



FUTURE-ORIENTED BIOGAS PRODUCTION

**Pumping, cutting, disintegration,
separation and feeding technology
machines and systems**

VOGELSANG – LEADING IN TECHNOLOGY





YOU CAN RELY ON IT

**Quality, experience and
expertise guarantee
future-proof technology**

As the inventor of the elastomer-coated rotary lobe pump, Vogelsang has numbered among the world's leading mechanical engineering companies in the area of pumping and cutting technology for decades. Above all in future-oriented sectors, such as biogas production, people have learned to trust the innovative character and outstanding quality of our systems.

Based on our extensive and varied experience, as well as our ongoing research, we not only develop components and systems with maximum functionality that ensure disruption-free operation over the long term – but we also ensure they are straightforward to operate.

Both the production process and quality of our machines testify to how seriously we take our commitment to providing our customers with the very best. The adaptability and versatility of our machines increases sales and extends service life, enabling plant operators around the world to respond effectively to current circumstances and regulatory changes.

VOGELSANG: SIMPLY MORE BIOGAS

Reliable components for individual tasks

Within the scope of the transition toward alternative energy sources, biogas plants now constitute a reliable pillar of gas and energy production in Germany as well as other countries worldwide. Their reliability and efficiency depend on the quality of the technology installed in the biogas plants – regardless of whether they are small biogas plants on farms or larger ones geared toward energy production. Vogelsang has stood by the pioneers of biogas technology from the very beginning and continues to support efficient and economical operation of their systems today.

Our knowledge advantage

The biogas plant components we develop and continually perfect have stood the test in applications all over the world. Research, continuous further development and innovative features help plant operators to maximize their gas yield.

Efficient biogas production

The cost-effectiveness of a biogas plant depends primarily on the efficiency of the individual components. Each and every one of our components contributes to that aim, thanks to the choice of high-quality materials and clever ways they work. The intelligent coupling of individual machines that are perfectly coordinated to work harmoniously with one another opens up even more opportunities for cost-effective biogas production.

A worthwhile investment

Vogelsang offers reliable products and efficient solutions tailored to your individual task requirements. The same goes for pumping, cutting and digester feeding technologies as well as the separation and disintegration of substrates: The more consistent the processes and more homogeneous the organic suspension fed into the digester, the higher the gas yield. This even reduces the energy costs for pumping and mixing the suspension, which in turn positively affects the overall balance sheet.*

Quality management

At Vogelsang, quality control is a self-evident necessity. None of our products leave the factory without being thoroughly checked first. We are constantly taking our quality management system to the next level, and regularly earn certification in accordance with DIN EN ISO 9001:2015 – after all, those who fail to improve will surely be left behind.

By the way: We also offer progressive, highly functional solid matter feeders for digester feeding that supports optimal bacterial culture development. Technology that helps operators to reduce the energy requirements of their biogas plant for mashing, stirring and pumping – while improving the gas yield at the same time.

For more information, see Vogelsang's brochure on "Innovative Solid Matter Feeding."

* Source: Results from an EU research project known as EU AGRO BIOGAS demonstrate cost reductions of up to 40 % and gas yield improvements of up to 8 %, relative to operation of a 500 kW biogas plant.

Vogelsang pumping, cutting, separating and disintegrating technology in biogas plants



HiCone® & CC series® (progressive cavity pumps)

- Easy and rapid replacement of pumping elements
- Minimal space requirement, special for service & maintenance
- Designed for heavy-duty use, suitable for pumping highly abrasive media and those with high foreign matter content
- HiCone: revolutionary geometry and groundbreaking adjustment system for long service life and low operational costs

VX series & IQ series (rotary lobe pumps)

- Compact, durable and easy to service & maintain thanks to QuickService design
- Self-priming and dry-running resistant
- Pumping direction can be changed as desired, suitable for a wide range of pumping tasks
- IQ series: Especially easy to integrate, operate and maintain



RotaCut®

- Cutter and heavy material separator in one
- Reliable chop down of fibrous and coarse matter in liquid
- Protects downstream plant components
- Optional online monitoring

CC-Cut/BioCut®

- Positive displacement pump with upstream RotaCut
- Design developed specially for the biogas sector
- Cut and blend the organic suspension and protects downstream plant components

RedUnit XRL

- Twin-shaft shredder for economical size reduction of highly coarse solid matter, such as fruit, vegetables and most organic waste
- Suitable for both dry and liquid media



DebrisCatcher

- Active heavy material separator with low energy requirement
- Robust and powerful
- Separates foreign matter and protects downstream plant components

DisRuptor

- Mechanical disintegration with high throughput
- Increases the target surface for the bacteria
- Reduces the viscosity
- Accelerates and increases gas production

XSplit®

- Press screw separator with unique features
- Reliable plug formation without the addition of auxiliary agents
- Easy to maintain and low-maintenance
- Very good cost-benefit ratio

THE PUMP REVOLUTION

The unique HiCone[®] progressive cavity pump with groundbreaking adjustment system

Patent pending adjustment system for minimal lifecycle costs

Unique conical geometry for several times longer service life

Pressure-stable delivery rate

Minimal space requirement thanks to compact design

Easy parts replacement without dismantling the pipes

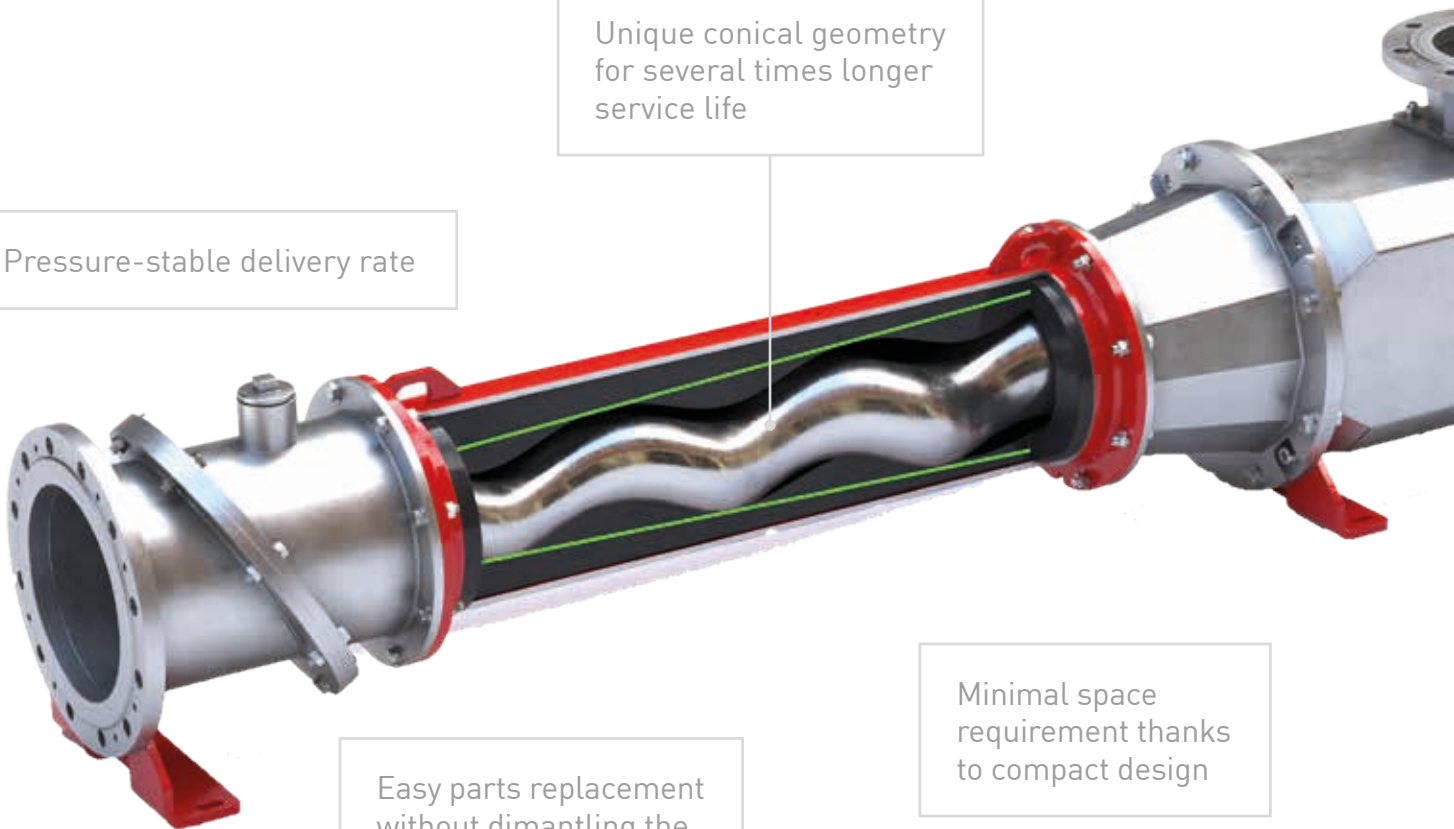

Intelligent automatic start-up system for lower power requirements

Adjustment of the pumping elements depending on the general conditions during operation

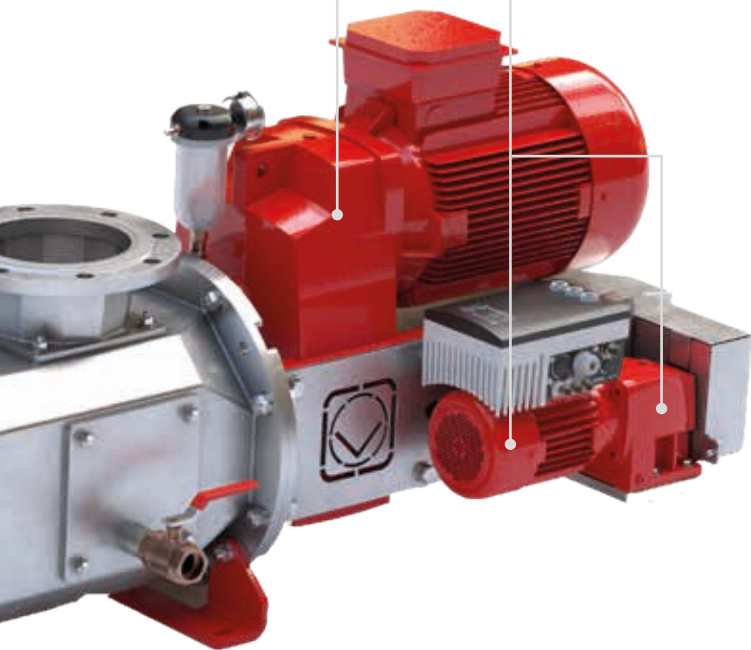

Real-time display of the wear status

High delivery rates of up to 290 m³ per hour

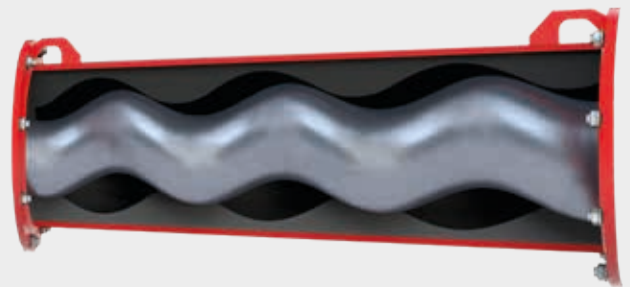

Unrivalled economy thanks to the conical shape for precise clamping

The unique, forward-tapering geometry of the rotor and stator enables ideal adjustment to the given flow medium. Biogas plant operators benefit from an unprecedented extension of service life and a far superior cost/performance ratio when using a HiCone progressive cavity pump compared to conventionally designed models.

Advantage of the HiCone®

- Reduced lifecycle costs
- Several times longer service life
- Optimal adjustment for maximum efficiency
- Intelligent automatic start-up for minimal power consumption on start-up
- Easy to maintain and low maintenance
- Features status indicator to avoid unexpected failures

OPTIMALLY TUNED FOR LONG SERVICE LIFE

The interplay of unique geometry and an innovative adjustment system saves energy and extends the service life of the new HiCone® progressive cavity pump

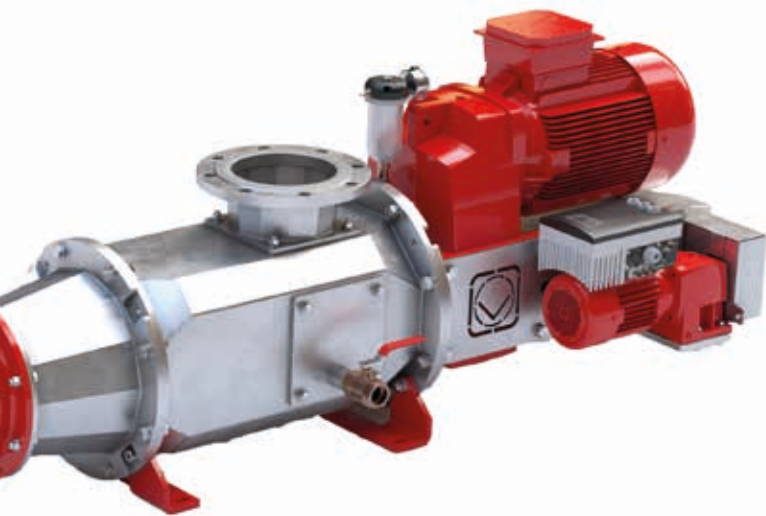

HiCone Automatik: adjustment during ongoing operation

After years of being out of the spotlight, biogas has finally come back into focus as a sustainable and flexible energy source. The challenge: developing an efficient technique that enables lower prices for production and supply.

As the inventor of the elastomer-coated rotary lobe pump, the RotaCut wet cutter with integrated heavy material separator, and many other groundbreaking machines and devices for the economical production of biogas and the utilization of digestate, it's only natural that Vogelsang has also worked toward optimizing the operating principle of progressive cavity pumps. We have already made a decisive breakthrough that helps plant operators by implementing rapid parts replacement for pumps in the CC series. The new progressive cavity pumps of the HiCone series furthermore feature a revolutionary, conical geometry and clever adjustment system, which enables longer service life than ever before while significantly reducing overall lifecycle costs.

Adjustable setting with extraordinarily easy handling

In order to react quickly and easily to different pumping tasks, the clamping between the rotor and stator of the pumps can be adjusted accordingly during operation. At the touch of a button or a mouse click in the control, the pump elements can be directly and precisely adjusted to operating parameters such as pressure, viscosity or temperature of. This keeps energy consumption as well as wear and tear at a minimum.

Maximum availability at the lowest possible power consumption

The result: a service life that is several times longer and an extremely high availability compared to conventional progressive cavity pumps. This represents a significant cost advantage, especially since the lower power consumption, which is always kept to a minimum, leads to further savings. In addition, simply starting up a HiCone series pump consumes significantly less electricity than usual. The reason for this is the intelligent automatic start-up system, which makes it possible to use smaller and therefore less expensive motors and power electronics to achieve the same result. At the same time, this start-up feature ensures energy-efficient operation, particularly with short pump cycles.

A NEW ERA

The pinnacle of efficiency: The durable HiCone® progressive cavity pump with QuickService functionality

Even the proven CC series pumps had already helped to avoid long downtimes thanks to their reliability and durability. And now, Vogelsang's new HiCone series pumps require even less maintenance, thanks to the unique, conical geometry of the pumping elements and the associated adjustment options. Users benefit from significantly longer service life and higher availability – leaving them with more time for essential tasks.



The current wear status of the pumping elements is displayed continuously. If a service call is required, it can be planned in advance. Even the pumps of the latest generation benefit from the proven QuickService principle when it comes to parts replacement. The swiveling mechanism enables quick and easy replacement of the pumping elements, with no need to remove the pump from the pipe system. In just a few simple steps, the stator and rotor can be removed and replaced as a complete unit – including the cardan shaft, if necessary.

And replacing the pre-assembled mechanical seal is just as easy: it can be replaced from the side after removing the geared motor.



HiCone progressive cavity pump

POWER-PERFORMER WITH MAXIMUM SERVICING CONVENIENCE

The practical CavityComfort
progressive cavity pump
for heavy-duty applications

Sturdy Cardan shaft
with protective sleeve



Seal replacement without
opening the pump

Quality cartridge
mechanical seal

Easy and quick
service with a highly
compact footprint



No disassembly of
pipes necessary

Clever combination: Reliable pumping and simple parts replacement

As rotating, positive displacement pumps, Vogelsang's CavityComfort (CC series) have proven themselves especially in the biogas sector. The robust progressive cavity pumps demonstrate their durability and reliable pumping performance in applications involving highly viscous and abrasive media that may also have a high content of foreign matter. Thanks to the innovative design, CC series pumps are especially favored when long periods of downtime for service and maintenance are simply unacceptable.

The principle

The CC progressive cavity pumps from Vogelsang combine a helical rotor with a stator surrounding the rotor, which also has a helical mount. Because of their geometry and the eccentric rotation of the rotor, cavities are created within the stator through which highly viscous media can be pumped. Since the pumping principle relies on sealing contact between the rotor and stator, pumping against high pressures is also possible without loss of power.

QuickService: Unique concept for rapid parts replacement

Our biogas customers appreciate the straightforward accessibility of pumping elements in CC series pumps. This enables parts to be replaced with speed and ease unparalleled among progressive cavity pumps – so the pump is ready for operation again in a short time. The stator and rotor to be replaced are simply replaced as a unit. The entire rotating unit (stator, rotor and Cardan shaft) can also be replaced if necessary. Alternatively, the stator can be removed after pivoting the pumping elements as unit out.

Next, the rotor and/or Cardan shaft are replaced, if necessary. But however you decide to proceed, it is not necessary to remove the sleeve that protects the robust Cardan shaft. And thanks to the clever swiveling mechanism, it's not necessary to disassemble parts of the pipe system for maintenance and repair.

Practical sealing change

The tried-and-trusted cartridge mechanical seal is used for the pump shaft seal. Since it is a preassembled mechanical seal, it can be quickly and easily replaced on-site – usually after removing the Cardan shaft through the pump chamber. When the parallel shaft geared motor is removed, the seal is accessible from the drive end, where it can be replaced with just a few motions – without opening the pump.

Clever details ensure a long lifetime

In designing the CC series, the Vogelsang developers worked to optimize many factors that affect service life. To prevent faults, for example, the Cardan shaft is generously dimensioned and is protected by a durable sleeve as standard. Sturdy parallel shaft geared motors supply the drive power. The flow-optimized StreamLine suction housing ensures extremely large free passage within the entire pump and avoids blockages. As an alternative, the MultiConnect suction housing allows multiple pipe systems of different sizes and connector forms to be easily and directly connected.





Rotary lobe pumps from the VX series

RELIABLE PERFORMANCE, FLEXIBLE APPLICATIONS

Vogelsang rotary lobe pumps – proven reliable in the widest variety of pumping tasks

Pumping liquid manure or wastes and substrates from industrialized agriculture, in particular, requires sophisticated, durable and powerful pump technology. Abrasive solid and fibrous matter or especially viscous liquids set the bar high for both suction power as well as pump durability. In the worst case, clumps and large disruptive and foreign matter can result in pump failure, thereby bringing additional systems to their knees, such as solid matter feeding.

We have guided them from invention to perfection. Today, elastomer-coated rotary lobe pumps set the standard worldwide for reliable and durable pump technology in many sectors.



Advantages of Vogelsang pumps

- Minimal space requirement thanks to compact design
- Suitable for all applications with easy handling due to reversibility of pumping direction, self-priming and dry-running resistant
- Resistance to foreign matter thanks to the innovative InjectionSystem
- Economical operation thanks to high efficiency and pulsation-free HiFlo lobes
- Easy to maintain and easy to service, high availability thanks to low downtime

ALWAYS AT THE FOREFRONT OF TECHNOLOGY

Whether standard models or custom solutions

Since Vogelsang rotary lobe pumps have proven themselves for decades in industry and agriculture, they are also used in thousands of biogas plants around the world. Thanks to continual further development and innovative features specially designed for the sector, they deliver efficient pumping and high maintainability – a decisive trump card in the hand of any economically minded operator.

The principle

Vogelsang rotary lobe pumps are contact-free, rotating, positive displacement pumps. Thanks to pulsation-free HiFlo rotary lobes, they deliver extremely low vibration

and even pump performance. Their unique design makes the pumps resistant to both foreign matter as well as running dry. The flow rate increases in proportion to the speed, so Vogelsang rotary lobe pumps have proven themselves to be an efficient choice for virtually any type of pumping task in a biogas plant.

Maximum versatility for biogas

The uses of Vogelsang pumps are virtually unlimited. Vogelsang rotary lobe pumps pump a wide range of media, from digestate to abrasive media like liquid manure containing sand, through to highly viscous organic suspensions with a high content of fibrous and solid matter. Thanks to the free passage of up to 90 mm, even large pieces of matter can pass through the pump.

Compact and space-saving

These compact pumps can be integrated into any system – even in the most limited of spaces. Vogelsang rotary lobe pumps are also very easy to retrofit in most cases.

Practical, economical and easy to maintain

Vogelsang pumps are easy to operate and maintain. This ensures low downtime, high availability and, above all, low operating costs.

Simply open the cover for easy access to the pump chamber thanks to the QuickService design. Wear parts can be replaced in the blink of an eye without completely removing them from the pipe and disassembling the pump. For more stability when working with high pressures, QuickService pumps are equipped with a third support bearing in the cover.

Drives

A selection of combustion, hydraulic and electric motors are available in different versions – driven by a geared motor or, in a more compact fashion, a belt with piggy back electric motor. All pumps can be designed so that the control functions occur via a variable frequency drive to ensure optimal operation at all times.

Shaft warranty

A large cross-section, no recesses – the result: Vogelsang pumps have break-resistant shafts! For this reason, we provide a five-year guarantee against internal shaft breakage* for all pumps in the VX series.

* Under the normal conditions of use in accordance with our terms of warranty

Sealing technology for professionals

For rapid and reliable seal replacement, cartridge mechanical seals have been the standard for years in VX series pumps. The completely preassembled units contain all components, thereby ensuring high availability and operational reliability. Special units of these 100 percent tested seals are available for biogas plants as required.

Vogelsang InjectionSystem

In conventional rotary lobe pumps, foreign and solid matter does not immediately enter the pump chamber, but instead rotates in front of the pump chamber. This often results in damage as well as increased wear on the lobe tips. The innovative InjectionSystem enables foreign matter to be injected directly into the opening pump chambers. This prevents collisions with the lobe tips. The internal sealing of the pump is also increased. The flexible injection modules can be adapted on-site for a different flow direction.

Control technology

The implementation of progressive control technology realizes a significant increase in the performance and efficiency of our rotary lobe pumps. Pressure, current consumption and (optionally) speeds are monitored constantly; the correlations between them are intelligently linked. In this way, the Performance Control Unit (PCU) is able to automatically register the load and ensures that the pump is operated in the optimum range, using appropriately defined control interventions.

Series

The VX series rotary lobe pumps are available in four series. Each individual pump is configured according to the requirement and case of application. The interior coating, lobe material and drive type are determined individually according to the need of your biogas plant.

Special designs

Upon request, we can also develop special designs in-house to meet your specific requirements. For example:

- Multi-chamber pumps
- Submersible pumps
- Mobile pump systems
- Combination of drives
- Radial wear plates
- ATEX-compliant

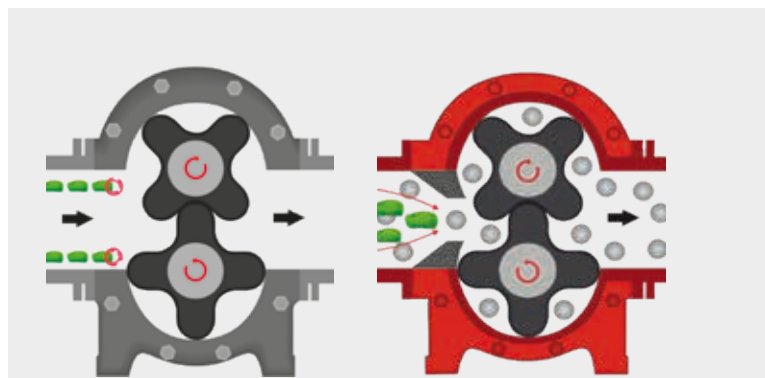

A vortex forms upstream from the inlet in rotary lobe pumps of conventional design. Foreign matter that damages the lobe tips becomes trapped here.

The Vogelsang InjectionSystem prevents vortex formation. It reduces damage due to foreign matter and increases efficiency as well as intake capacity.

UNIQUE, EASY TO MAINTAIN AND HANDLE

Greater cost-effectiveness
thanks to reduced maintenance
and service



IQ152 rotary lobe pump

With its completely novel design, the Vogelsang IQ series proves that it's worthwhile to rethink even a technology that has been successful for years. The number of essential components in the pump chamber has been significantly reduced while the basic construction has been completely redesigned. This makes both operation and maintenance even easier compared to the VX series.

The principle

The IQ series rotary lobe pumps are positive displacement pumps equipped with the pulsation-free HiFlo rotary lobe. Thanks to the InjectionSystem incorporated into the pump housing, they have an extremely high tolerance for foreign matter, which protects the lobes from damage and ensures consistent intake capacity. The liquid reservoir integrated as standard additionally prevents the pumps from running dry.

In contrast to the VX series, the pump housing of the IQ series consists of just a single component. It can be dismantled with just a few movements, giving access to the pump elements, while the pump remains firmly screwed into the pipe.

Simple integration

The variable series connecting parts on IQ series pumps are suitable for the most common installation situations. This means that they can be quickly and easily attached or installed in a wide range of positions, including to tank vehicles and mobile units, without the need for special connectors.

Long service life and low operating costs

The InjectionSystem does more than increase the intake capacity and efficiency of the pumps. The intelligent foreign matter handling increases the service life of the pump – up to 150 percent in field tests.

Along with the simplified design, the fact that the number of central spare parts has been reduced by half compared to the conventional design helps save costs. The spare parts themselves are also less expensive and less time is required for maintenance and parts replacement: IQ series pumps are designed so that it takes less than half the time to replace all wear parts – including rotary lobes, wear plates, pump housing and seal.



IQ152–158 mounted on a torsion-resistant motor base. The flexible connection parts allow easy adaption to common installation situations.



Advantages of the IQ series

- Free access to pumping elements in next to no time
- Intelligent foreign matter handling
- Excellent suction capacity and integrated dry-running protection
- Significantly reduced spare parts costs

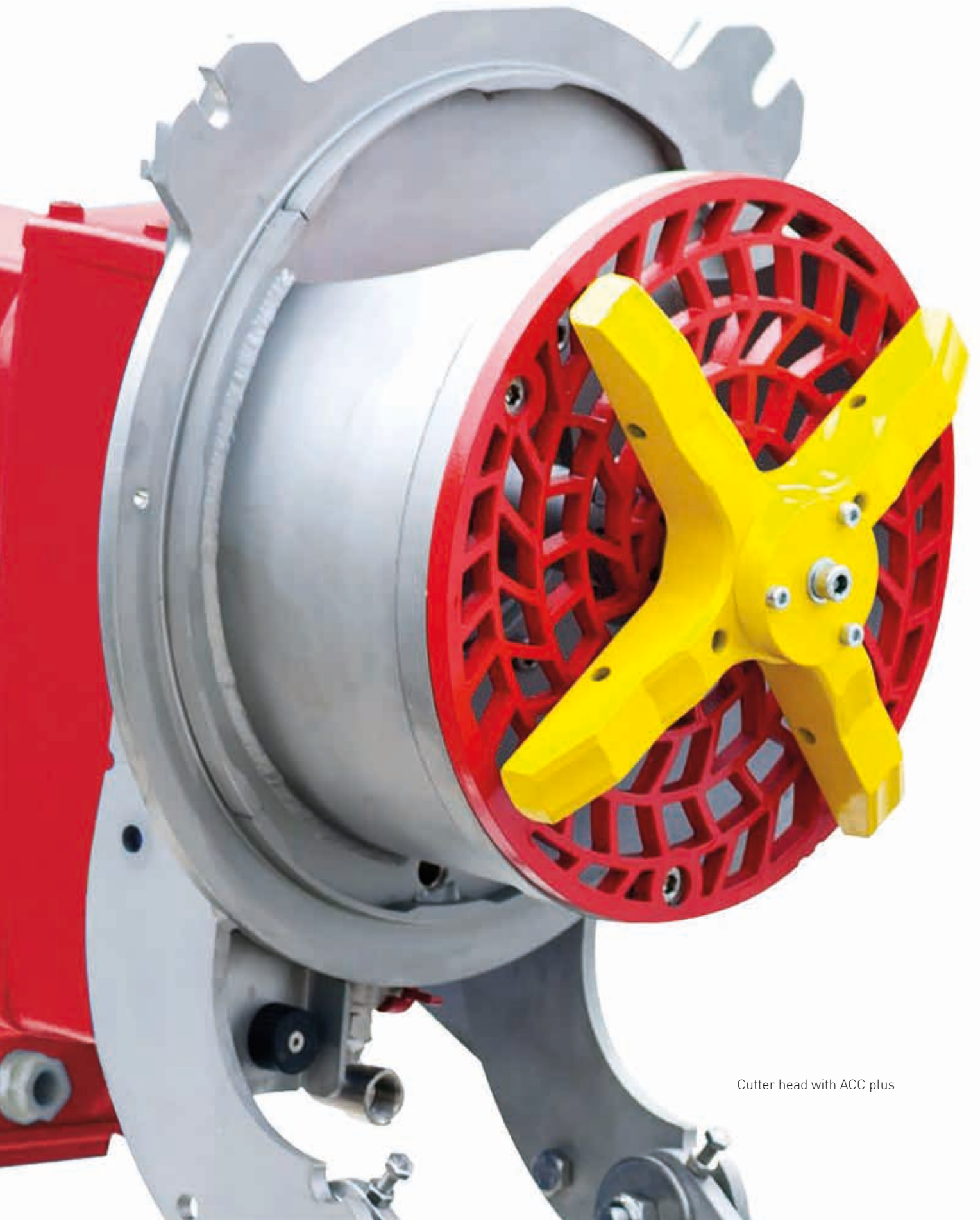

Cutter head with ACC plus

FEWER INTERRUPTIONS AND HOMOGENEOUS SUSPENSIONS

Der RotaCut® with integrated heavy material separator – for reliable processes and low maintenance costs

Trouble-free, consistently running processes are indispensable for efficient gas production in biogas plants. When dung and grass silage are used, more metal parts, stones and other disruptive matter such as hoof chunks, branches, straw ropes and nets end up in the biogas plant. There they clog or even damage plant components all too often. At the same time, the viscosity of the organic suspension rises, especially when extremely fibrous biomass such as straw or even forage wagon grass are fed in, which rapidly results in floating layers in the digester. All of these impair the efficiency of the plant and increase energy requirements for mixing.

The RotaCut reliably separates heavy material, macerates coarse matter and cuts fibrous biomass. It homogenizes the organic suspension, thereby ensuring reliable and economical plant operation. Whether liquid feeding, digester circulation or transfer to the post digester, or returning recirculate; upstream of separation or upstream of the external heat exchanger – the RotaCut has versatile uses and can significantly contribute to boosting the efficiency of the biogas plant.

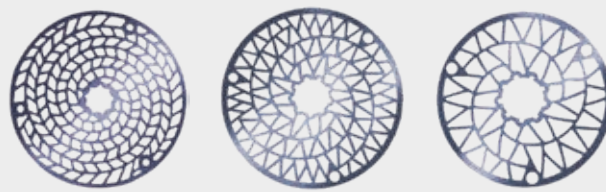

Vogelsang uses its proprietary software to calculate the optimized geometry for every size-reduction ratio. For you this means: You always get the best geometry for smooth running, with minimal wear. The cutting screens are produced from wear-resistant special steel and are reversible.

RotaCut® advantages

- Reliable cutting of fibrous and coarse matter
- Foreign matter protection for all downstream components
- Mixer and pump power requirements are lower thanks to more homogeneous and flowable suspensions
- Increased substrate surface area, which means higher gas yield
- Fully automatic, interruption-free and low-maintenance operation thanks to Automatic Cut Control (ACC)
- Fully automatic monitoring of the unit as well as automatic fault elimination with PCU (optional)

The principle

The RotaCut is a macerator for more or less viscous media that combines two functions: heavy matter separation and solids reduction. It processes solid matter content into easily pumpable media. While the medium continually flows through the RotaCut, heavy material such as stones or metal parts are separated out by gravity. They are easily removed later through a cleaning port. All floating and suspended substances within the medium (fibers, hair, bones, wood, entangled material, whole plant silage or grass) are transported to the cutting screen by the liquid current and macerated by rotating, self-sharpening cutting blades. The medium is homogenized at the same time.

ACC: Constant power, long service life

Automatic Cut Control (ACC) consistently ensures excellent cutting performance by the RotaCut. There's no need for manual maintenance as the ACC automatically adjusts the cutting blades of the RotaCut and keeps the necessary contact pressure constant – as high as necessary and as low as possible. This means the pressure can be adapted to the medium at any time without interrupting operation. This not only reduces power consumption requirements, it also reduces wear and significantly extends the lifetime of the cutting blades.

Always informed with ACC plus

The optional ACC plus feature enables online monitoring of the RotaCut for the RCQ and RCX series. An external display and/or the control graphically indicates the status of the cutting blades and informs you when the blades require changing, so you can plan spare part orders and maintenance well in advance. ACC systems are therefore the foundation of efficiency gains and the greatest degree of automation for continuous use applications.

Performance Control Unit (PCU): Efficiency through intelligent control technology

If multiple pumps and cutters are grouped together into one unit, the PCU checks processes in each machine, as well as other parameters. It ensures optimum communication between the machines and continuously monitors the loads of the individual units. Individual components are controlled so as to ensure that the unit as a whole achieves optimum results. The PCU detects faults early on and rectifies them before they pose a problem – fully automatically. All the parameters can be transferred via a Profibus connection to the central control for remote monitoring. When the operating parameters are controlled fully automatically and based on the given situation, operators benefit from minimized faults, a longer lifetime and reduced costs.

Remove foreign matter more quickly with the Debris Removal System

Depending on the choice of substrates, large quantities of foreign matter end up in biogas plants. Removal has generally required considerable effort, which is why it's well worthwhile to supplement the RotaCut RCX with the innovative Debris Removal System (DRS) from Vogelsang. The foreign matter separated out by the RotaCut is removed during ongoing operation – with no need to switch off or open the RotaCut RCX.

Compared to conventional solutions, the DRS makes it possible to do so in just one-sixth of the time – and can even be partially automated using an appropriate control. Moreover, only approx. 15 l of medium is removed along with the heavy material. This both prevents extended downtime of the RotaCut RCX and means that there is only a small quantity of medium to return to the system.



RCQ-33G Inline



RC 10000 Compact XL



RCX-58G with DRS



Advantages of the ACC

- No manual blade adjustment required; fully automatic, uninterrupted operation
- Contact pressure can be readily adjusted to the medium without interrupting operation
- Low operating costs thanks to minimum wear and low current consumption
- Optimal results due to consistently excellent cutting and constant size-reduction ratio

Advantages of the PCU

- Reduced maintenance due to autonomous operation
Efficient operation due to fully automatic and situation-dependent control of operating parameters
- Lower operating costs due to a longer lifetime
- Automatic fault elimination

EFFECTIVE COMBINATION

The CC-Cut and BioCut® developed
specially for biogas plants:
Positive displacement pump and
cutter in one

Reliable pumping
of a wide variety of
demanding media

Economical pumping thanks
to optimal coordination of
components

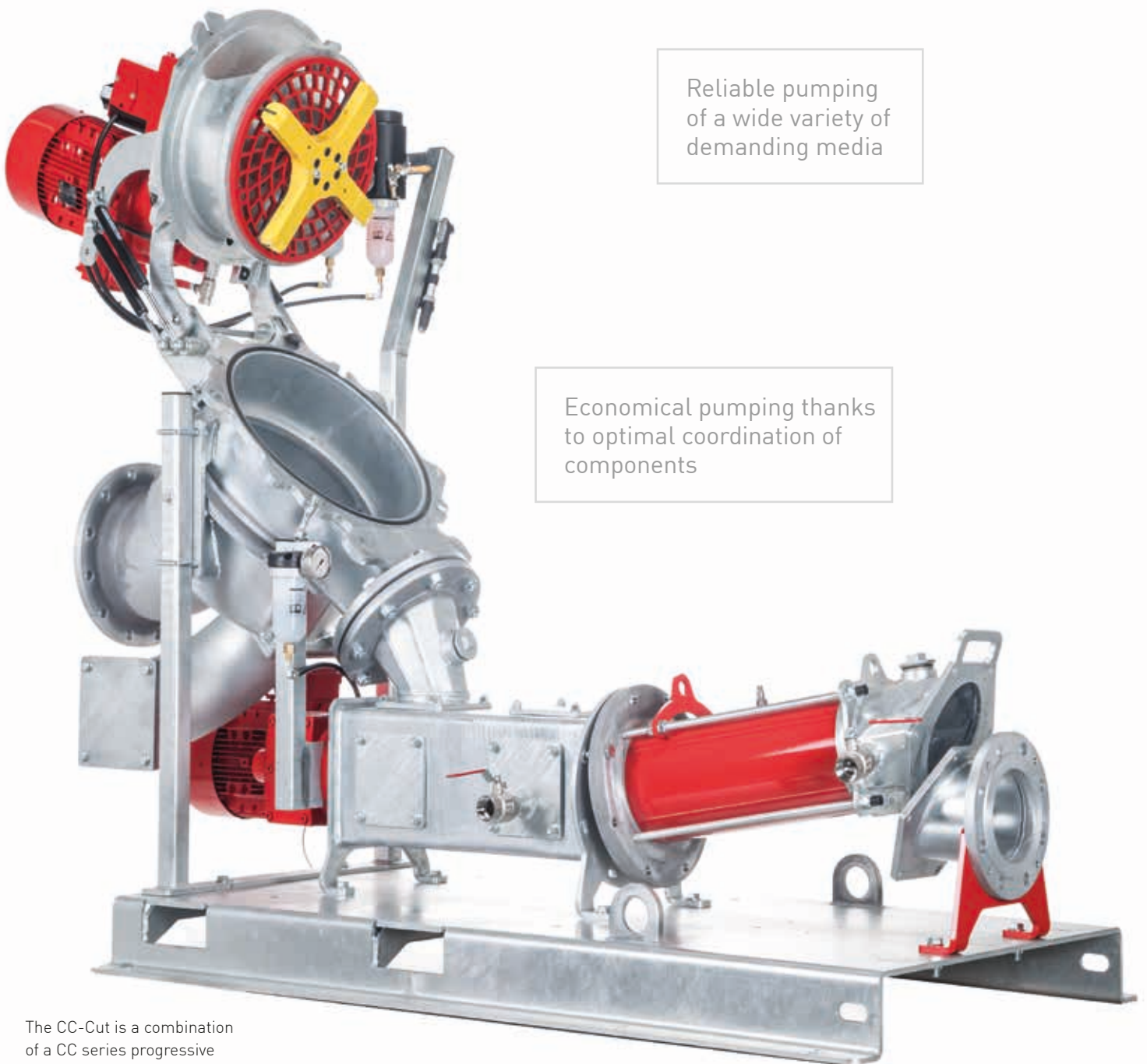

The CC-Cut is a combination
of a CC series progressive
cavity pump and a RotaCut.

Separation of heavy material
and maceration of disruptive
matter upstream of the pump

Compact design with
low space requirement

Quick and easy
on-site maintenance



The BioCut is a combination
of a VX series rotary lobe pump
and a RotaCut.

Economical pumping thanks to two compact pump systems

In most biogas plants, it's necessary to prime, pump and prepare highly diverse liquid media. They usually contain a great deal of solids and fibrous matter, as well as disruptive matter like branches, hoof clumps, etc. – that are highly viscous and loaded with many foreign matter. Vogelsang has developed two compact pump systems especially for these kinds of demanding pumping tasks: BioCut and CC-Cut. Both comprise a robust positive displacement pump with a powerful upstream cutter.

The principle

While the BioCut is equipped with a self-priming rotary lobe pump, the CC-Cut pumps the media fed in using a progressive cavity pump. Both include an integrated, specialized model of the proven RotaCut, giving the entire unit extremely compact dimensions. With low space requirement, the machines act as the central pump system, ensuring that heavy material like stones and metal parts are reliably separated from liquid manure, organic suspensions or other liquids.

At the same time, they macerate the disruptive matter contained in the medium as well as the biomass intentionally fed into it, and homogenize the suspension for smooth and uncomplicated pumping. The excellent disintegration reduces both the tendency toward formation of layers as well as the viscosity of the medium – the energy requirement for mixing is minimized and the gas yield is increased.

Easy to maintain

Like the individual Vogelsang components for biogas plants, maintenance and parts replacement are quickly and easily performed with the BioCut and CC-Cut as well. All wear parts can be replaced on-site without dismantling the components. Here too, the excellent accessibility of the pumps for maintenance that Vogelsang customers appreciate is fully retained.

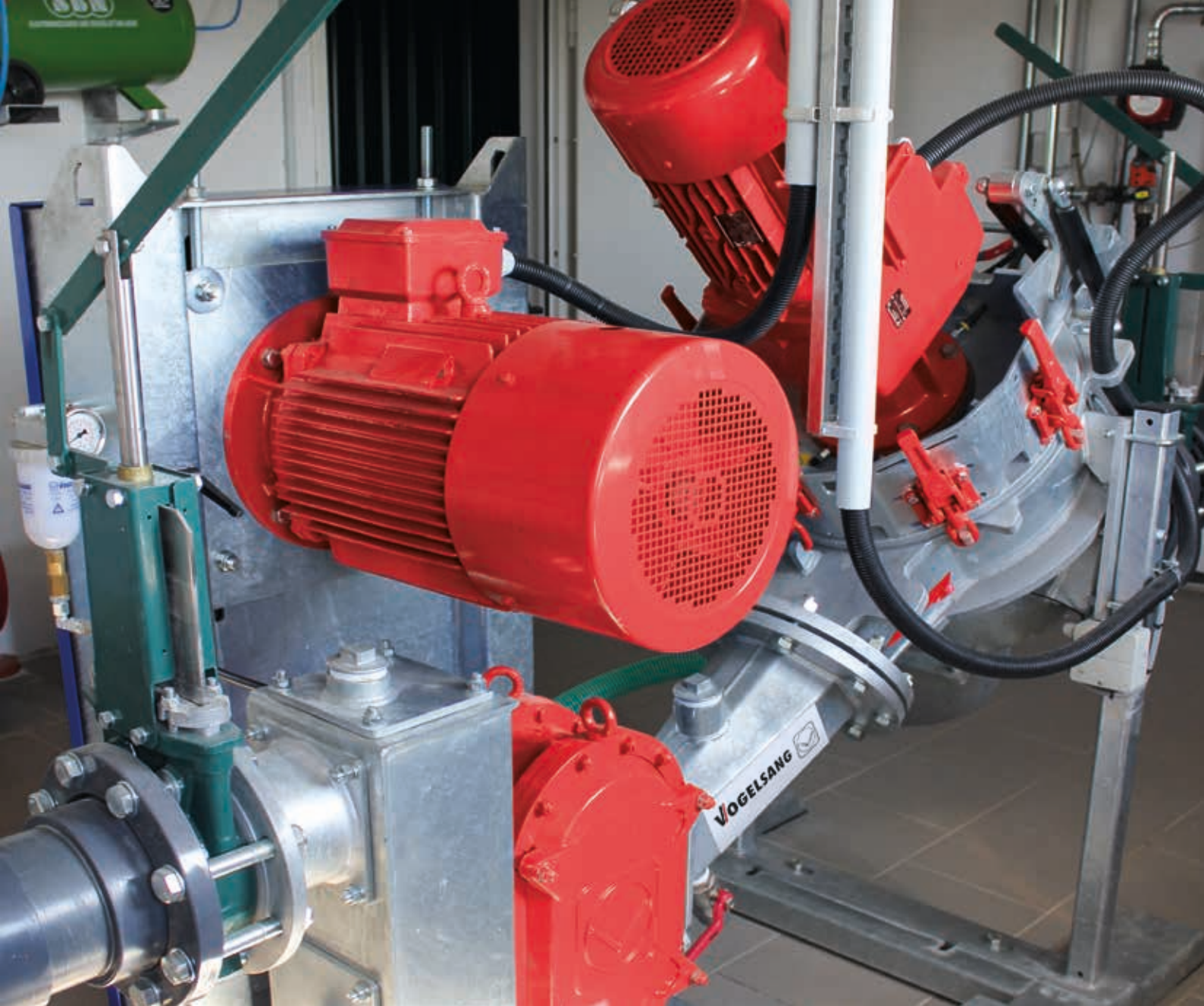

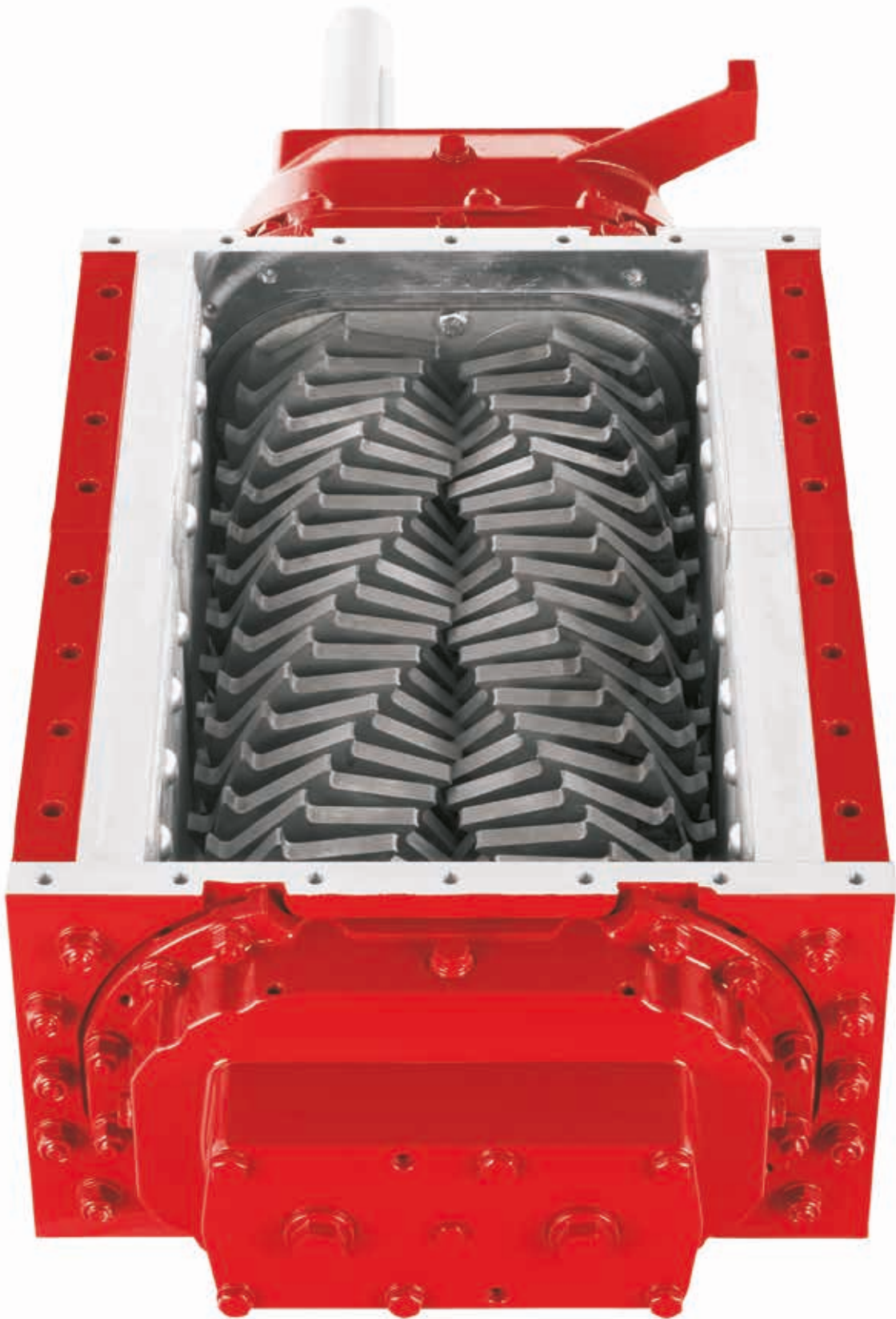

OPTIMALLY PREPARED IN THE FERMENTATION PROCESS

The RedUnit XRL twin-shaft shredder for processing high-volume solid matter

The sturdy RedUnit XRL is primarily intended to reduce coarse material such as fruit, vegetables and other organic waste. Before they are fed into the digester, crops, food remnants and food industry waste must be prepared in such way that they can be optimally processed in the biogas plant without causing any interruptions. The RedUnit XRL increases the surface area of the substrate thereby accelerating fermentation while simultaneously protecting the biogas plant from trouble, damage and expensive repairs.

The principle

The RedUnit XRL uses its monolithic single-piece Ripper rotors made of special steel to shred the solid matter fed into it. The sharp ends and corners cut long-fibered matter while coarse and brittle components are ground up. The size-reduction ratio is adjusted by modifying the width and contour of the RedUnit blades.

Easy-to-maintain design

The Ripper rotors are mounted on generously sized shafts. In addition to the already very robust QD design with two-sided bearings, the rotors are produced from a single piece, which ensures high functionality and stability. The customer-oriented QuickService concept for which Vogelsang is known allows for fast, on-site maintenance.



Advantages of the RedUnit XRL

- Long service life thanks to rugged design
- High availability since maintenance requires only minimal time
- Economical shredding of large-volume and coarse substrates
- Rapid decomposition and higher gas yield thanks to substrate preparation optimized for the digester

TOP TECHNOLOGY FOR FAULT PREVENTION

The DebrisCatcher delivers
maximum plant protection thanks to
active foreign matter separation

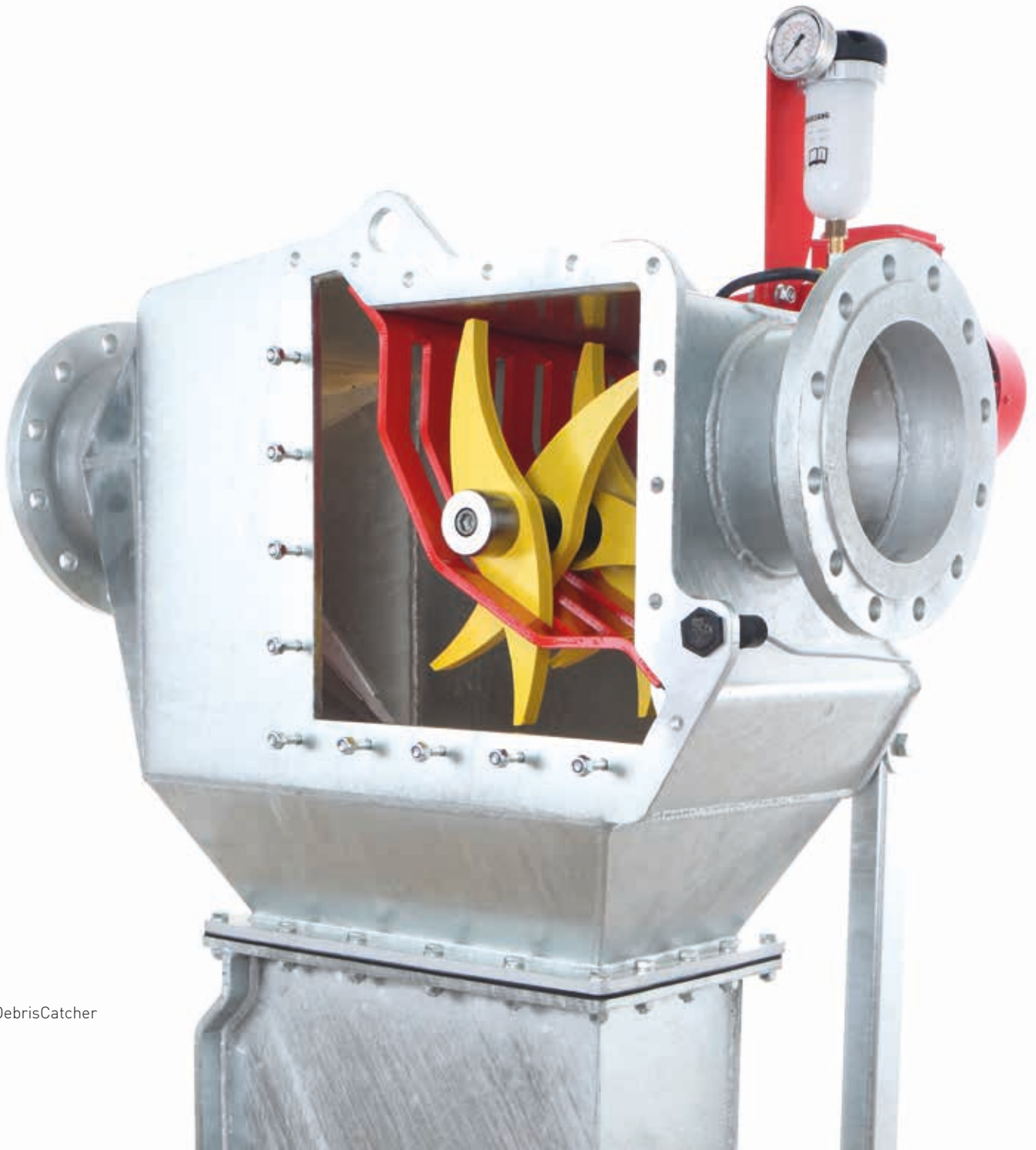

All too often, heavy material, such as metal and stones, complicates the lives of biogas operators. Aside from the fact that they become lodged in the digester and over time reduce the fermentation volume, they often cause damage and faults in pumps, mixers and other plant components. As the specialist for industry-specific pump technology, Vogelsang offers a solution for active heavy material separation with unrivaled energy efficiency: the combination of a passive heavy material separator and active foreign matter separation in the form of a sieve and non-contact clearing units. The compact DebrisCatcher therefore complements the Vogelsang portfolio for protecting pumps and plant components to ensure the target yield is achieved – and not impaired by fault-related operational interruptions.

The principle

The unique housing shape of the Vogelsang DebrisCatcher was developed with the help of flow simulations for optimal use of gravity for separation of metal parts and stones. The heavy material contained in the medium reliably sinks into the separator. Other foreign matter carried along with the liquid flow is retained at the sieve, from which it is guided into the separator by the rotating clearing units.

Effective and durable

The low speed of the clearing units combined with their non-contact manner of functioning reduces wear to a minimum. A counter bearing gives the drive shaft the stability it needs, even for stubborn foreign matter. In spite of the low drive power, high levels of torque are available. Flows of up to 150 m³/h are easily possible at DM content of up to 13 percent. This guarantees that the DebrisCatcher functions reliably – damage and blockages to pumps and fittings caused by foreign matter are avoided.

Fully automatic removal of foreign matter with the DRS

In combination with the innovative Vogelsang DebrisRemoval System, the DebrisCatcher can eject the foreign matter that has been separated out without requiring stoppages or opening the machine.



Applications

The DebrisCatcher is particularly suitable for biogas plants that handle pre-shredded substrates, such as corn silage or finely chopped grass silage, but which can also contain foreign matter, e.g., in the form of fresh slurry or amounts of manure.

OUTSTANDING FLEXIBILITY

The individually adaptable
DisRuptor for mechanical
disintegration of solid matter



DisRuptor
DR7000

Optimal substrate disintegration is key for determining biogas yield. This is why Vogelsang also offers a mechanical alternative for disintegrating substrates: the new, flexibly designed DisRuptor. The reduction of the particle size and the simultaneous defibering increases the surface area of the solid matter used. This helps bacteria reach the nutrients better, accelerates conversion and increases the gas yield.

The principle

The DisRuptor functional unit consists of a rotor with six blades as well as an outer DisRuptor ring. At high rotor speeds, the solid matter in the suspension is milled and frayed in the narrow gap between the rotor unit and the external ring. The gap can be individually adjusted to the specific application and the substrate. Thanks to these unique features, the DisRuptor offers particularly flexible and efficient mechanical treatment.

Adjustable mechanism

The DisRuptor adjustment mechanism is simple to handle. With hydraulic assistance, the DisRuptor head can be easily pivoted upwards to enable easy access to the functional unit. Few steps and no special tools are required to individually adjust the gap between the blades and the outer ring for each substrate.

Economical side effect

Since disintegration of substrates with the DisRuptor helps to prevent floating layers and reduces the viscosity of the organic suspension, power consumption and energy requirement of mixers and pumps is significantly reduced. Moreover, wear on the ring and blades can be compensated for by realignment – and their service life extended accordingly.

Outstanding performance

The DisRuptor, Vogelsang's well-thought-out complement to the product range for biogas plants, has even won over independent committees of experts: The DisRuptor was the "WINNER 2016" of the EnergyDecentral INNOVATION AWARD.



Advantages of the DisRuptor

- Increases the target surface for the bacteria
- Reduces the viscosity
- Accelerates and increases gas production
- Ensures high throughput

CLEAN SEPARATION OF SOLID AND LIQUID

**The XSplit® separator:
economical and easy to maintain
thanks to innovative design**



XSplit separator

The XSplit® separator from Vogelsang combines the tried and tested concept behind press screw separators with a completely new design, resulting in unique features and many user advantages.

When developing the new XSplit separator, Vogelsang took up the tried and tested functional concept of the press screw separator, and completely redesigned the technical implementation. The drive is now arranged on the solid matter outlet side, which gives the XSplit an excellent cost-benefit ratio and unique features.

Positioning the drive behind the solid matter outlet means there's no need for an extra shaft seal. This reduces the both cost of spare parts and the time required for maintenance work. Access to the sieve basket and press screw is also possible in a few simple steps. As you've come to expect from Vogelsang, service and maintenance work can be performed quickly and easily on-site. In addition, the startup behavior of the new XSplit separator is significantly quieter in comparison.

A sealing disc made of high-quality elastomer in the pressing area allows the XSplit to achieve a dry matter content of up to 40 percent – making it superior to other press screw separators. The disc ensures optimal resistance to the pressure applied by the press screw and, together with the press screw, ensures uniform and reliable plug formation without extra aids – with nearly zero initial leakage. A range of sieve variants suited to various media and consistencies is available, guaranteeing extremely reliable separation results.

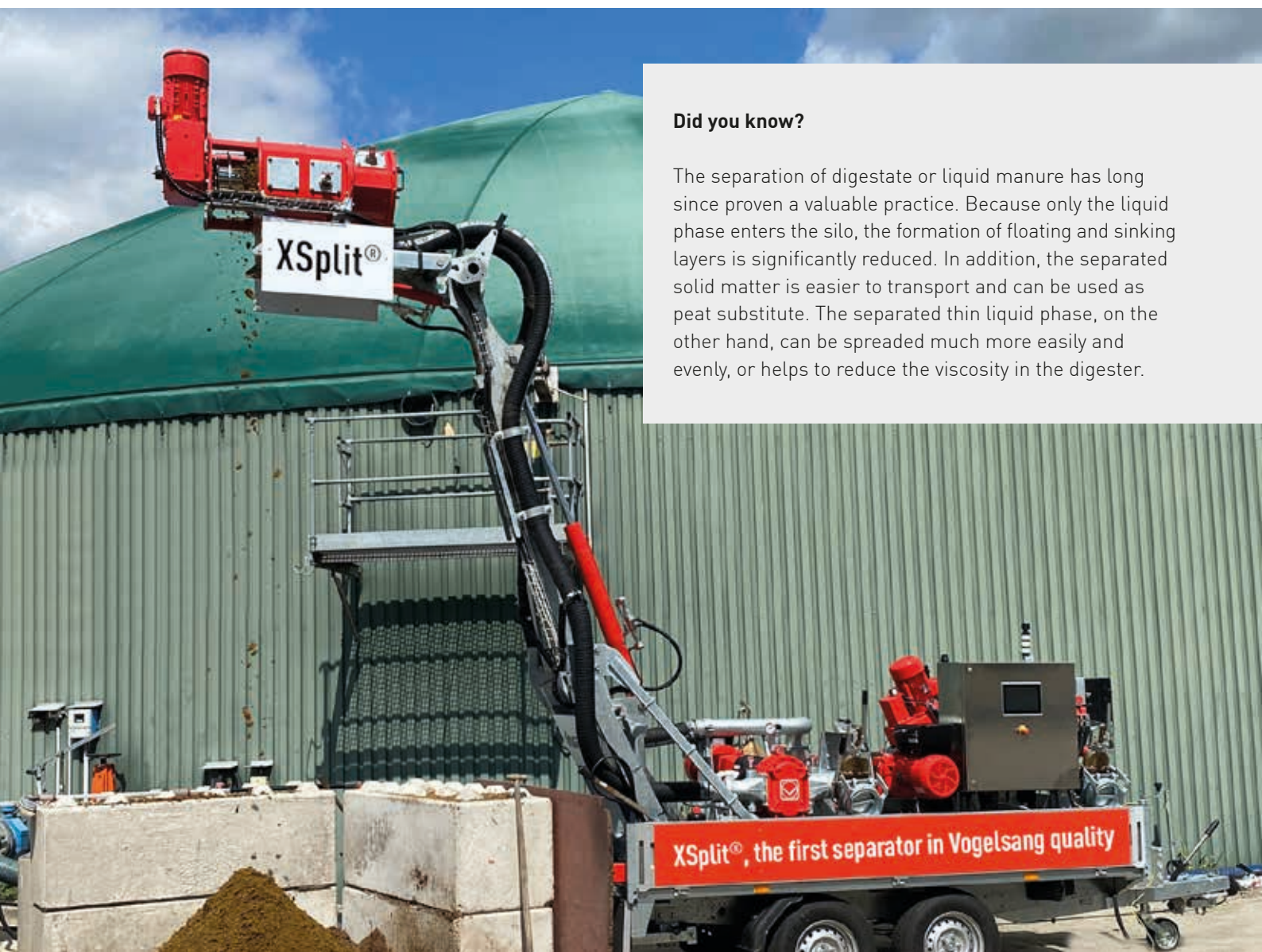

Did you know?

The separation of digestate or liquid manure has long since proven a valuable practice. Because only the liquid phase enters the silo, the formation of floating and sinking layers is significantly reduced. In addition, the separated solid matter is easier to transport and can be used as peat substitute. The separated thin liquid phase, on the other hand, can be spreaded much more easily and evenly, or helps to reduce the viscosity in the digester.

Minimal space requirement
thanks to compact design

Optimal separator
start-up behavior

Wide range of sieve variants
for reliable separation results
with every medium



Very easy access to the
sieve basket and press
screw for quick service

High dry matter
content of up to
40 percent possible

No extra shaft seal required thanks to the innovative drive arrangement behind the solid matter outlet

Individually adjustable pressing area for needs-based dry matter content

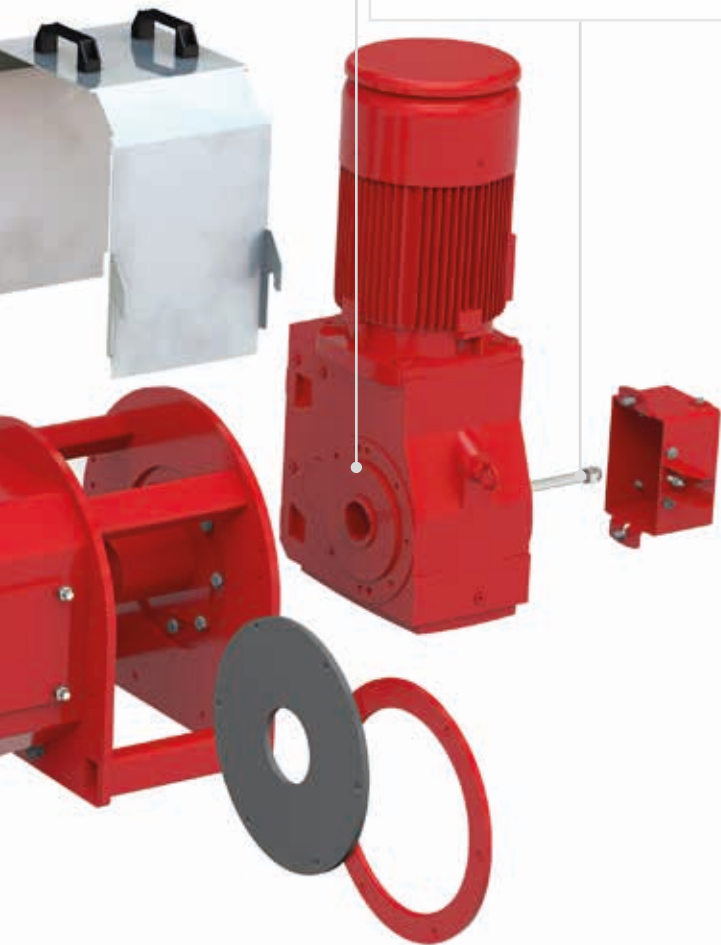

Reliable plug formation

Ideal separation results

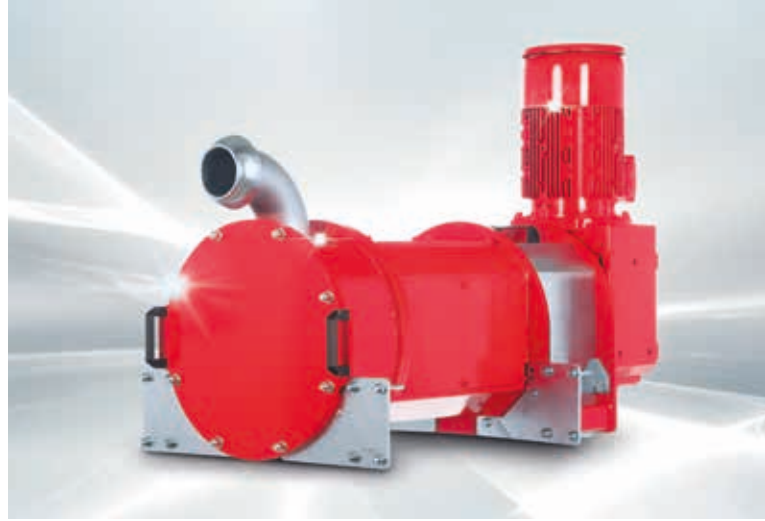

The easily accessible maintenance port provides very easy access to the press screw and sieve basket at any time.

Advantages of the XSplit®

- Up to 40 percent dry matter content
- The dry matter content can be easily adjusted individually
- Reliable plug formation without the addition of auxiliary agents
- No extra shaft seal required
- Easy to maintain and low-maintenance
- Very good cost-benefit ratio

MAKE DIGESTATE USEFUL

Vogelsang agricultural technology for modern and economical management of digestate and liquid manure

Soon after its establishment in 1929, Vogelsang was one of the most important manufacturers of tankers used in agriculture in northern Germany. The elastomer-coated rotary lobe pump invented by Helmut Vogelsang was used as mobile pump technology on slurry tankers – and was among the greatest advances in agricultural technology at that time.

It is therefore no surprise that Vogelsang, which, in the meantime, has become a mechanical engineering company with worldwide operations, has never neglected the agricultural sector when it comes to novel products and further developed ones. Today, the respected manufacturer offers a range of solutions, as modern as it is comprehensive, for pumping and spreading liquid manure, digestate and other fluid fertilizers. A success story you can be part of by using the products on your entire farm.

Pumps for the farm

Transferring, draining, filling – whatever the day brings, the job has to be done. With their many useful characteristics, Vogelsang rotary lobe pumps help you in your daily work. These features include the InjectionSystem and the Cartridge mechanical seal.

Equipment for spreading vehicles

Less foam, complete filling, large suction capacity, high flow rate and even draining: With the low-maintenance, compact Vogelsang rotary lobe pumps and RotaCut units, you can make the most of your spreading vehicle's potential.



Mobile solutions

Vogelsang provides maximum pumping power for effective spreading of digestate and liquid manure with field-side containers, filling stations and tankers – well-engineered solutions with powerful technology that really gets you ahead.

Variety of solutions

Vogelsang pumps enable a wide variety of configurations: permanently installed, on a three-point base, with an electric or hydraulic motor, or with a PTO drive.

It's easier with Vogelsang rotary lobe pumps

R series: Our classic models. Sturdy pump technology for simple applications.

Performance: max. 5 bar, max. 6,000 l/min

FarmerPump: Designed to meet the demands of agriculture. Durable and easy to use thanks to its oil circulation lubrication.

Performance: max. 8 bar, max. 4,500 l/min

VX series: Leading technology when it comes to safety, durability and maintenance. It includes HiFlo lobes, InjectionSystem, Cartridge mechanical seal and the unique QuickService concept for quick wear part replacement.

Performance: max. 12 bar, max. 23,600 l/min

GL series: More compact and lightweight with the same performance: The new new aluminum rotary lobe pump without gearbox is a real space-saving miracle. The GL series weighs less than half as much and is significantly shorter - a decisive advantage for integration in tankers!

Performance: max. 8 bar, max. 6,000 l/min

Special solutions for management of digestate and liquid manure

PowerFill: The hydraulically operated tank filling accelerator. Saves up to 30 percent of time when filling the tank and homogenizes the liquid manure during filling.

FillMaster: The effective solution in the liquid manure chain. The combination of a pump from the VX series with a boom or nozzle fills tankers quickly and easily.

Cutters

RotaCut MXL: The completely reliably and long-lasting cutting system. Combining it with a foreign matter separator for use on a tanker increases operational safety.

Vogelsang precision distributors

Precise and reliable distribution of liquid manure requires exact dosing. Vogelsang provides several options to meet this need:

DosiMat DMX: A hydraulically driven cutting and dosing system that is fed from above and evenly distributes liquid manure and digestate to the outlets using a rotor. This design principle guarantees high distribution precision and high operational reliability.

ExaCut ECL: The precision distributor based on rotor technology guarantees excellent cutting performance thanks to its self-sharpening cutting blades and distributes liquid manure and digestate homogeneously through 18 to 48 outlets. The integrated heavy material separator protects the entire spreading system from disruptive foreign matter.

ExaCut ECQ: The fast and easy to maintain precision distributor with integrated heavy material separator and extended service life. Thanks to the special design of the cutting tools, the ExaCut ECQ distributes liquid manure and digestate with unbeatable accuracy through 24 to 48 outlets.

Spreading close to the ground with Vogelsang trailing shoe and dribble bar systems

To spread liquid manure and digestate with as low emissions and as nutrient-efficient as possible, Vogelsang offers a wide range of powerful dribble bar systems and trailing shoe systems. With working widths up to 36 meters for tankers and up to 18 meters for self-propelled vehicles, systems are available for farms and fields of any size. Depending on the towing vehicle, the umbilical systems are excellent thanks to their low weight, high distribution precision and even discharge distances. Many equipment options give farmers and contractors the necessary flexibility and allow them to do their work efficiently.

Strip Till: Root-level liquid manure and digestate fertilization

Aside from the conventional dribble bar and trailing shoe systems, Vogelsang offers Strip Till equipment to cater to the rising interest in Strip Tillage. Depending on the characteristics of the field, the XTill VarioCrop till the soil optimally for seeding row crops, combining tillage with root-level fertilization.

Economical solutions for a wide range of tasks



VX series & IQ series

With their outstanding characteristics – compact design, self-priming, easy to service and maintain – Vogelsang rotary lobe pumps are the economical solution for many different pumping tasks.



RotaCut®

Wet macerator and heavy material separator combined. Reliably separates foreign matter such as stones or metal parts and effectively macerates fibrous and coarse matter in liquid media, thereby ensuring more homogeneous and flowable suspensions.



CC-Mix

For economical feeding of flowable to slightly pasty solid matter. Optimal mixing with a liquid suspension increases the gas yield and reduces the power consumption of the pumps and mixers.



HiCone® & CC series®

For pumping highly viscous and abrasive media, and media with a high proportion of foreign matter. The revolutionary conical shape of the rotor and stator as well as the innovative concept for adjustment and service sets new standards for lifetime and ease of maintenance.



RedUnit XRL

Facilitates efficient fermentation of fruit, vegetables and various organic waste. The powerful twin-shaft shredder cost-effectively treats large and coarse solid matter in liquid or dry media.

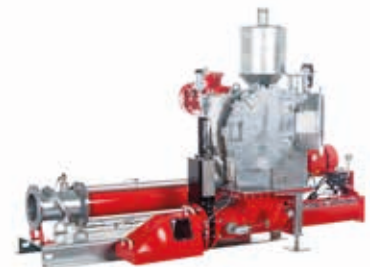

PreMix®

The universal 4-in-1 solid matter feeder. Separates foreign matter out, treats a wide range of cosubstrates optimally, chops down coarse and fibrous particles and feeds several digesters with optimally treated suspension.



DisRuptor

Flexible and efficient mechanical disintegration of structured substrates thanks to adjustable function unit. Accelerated conversion and increased gas yield thanks to larger surfaces. Prevents floating layers and reduces the viscosity of the organic suspension.



XSplitt®

The unique separator with excellent cost-benefit ratio. Combine dry substance contents of up to 40 percent with reliable plug formation without the addition of auxiliary agents and high ease of service.



EnergyJet®

The efficient solution for trouble-free digester feeding with renewable resources and dung. The wear and foreign matter-resistant system mixes structured substrates with a liquid suspension to a well-mashed organic suspension.

ECONOMICAL BIOGAS PRODUCTION

with reliable and efficient technology

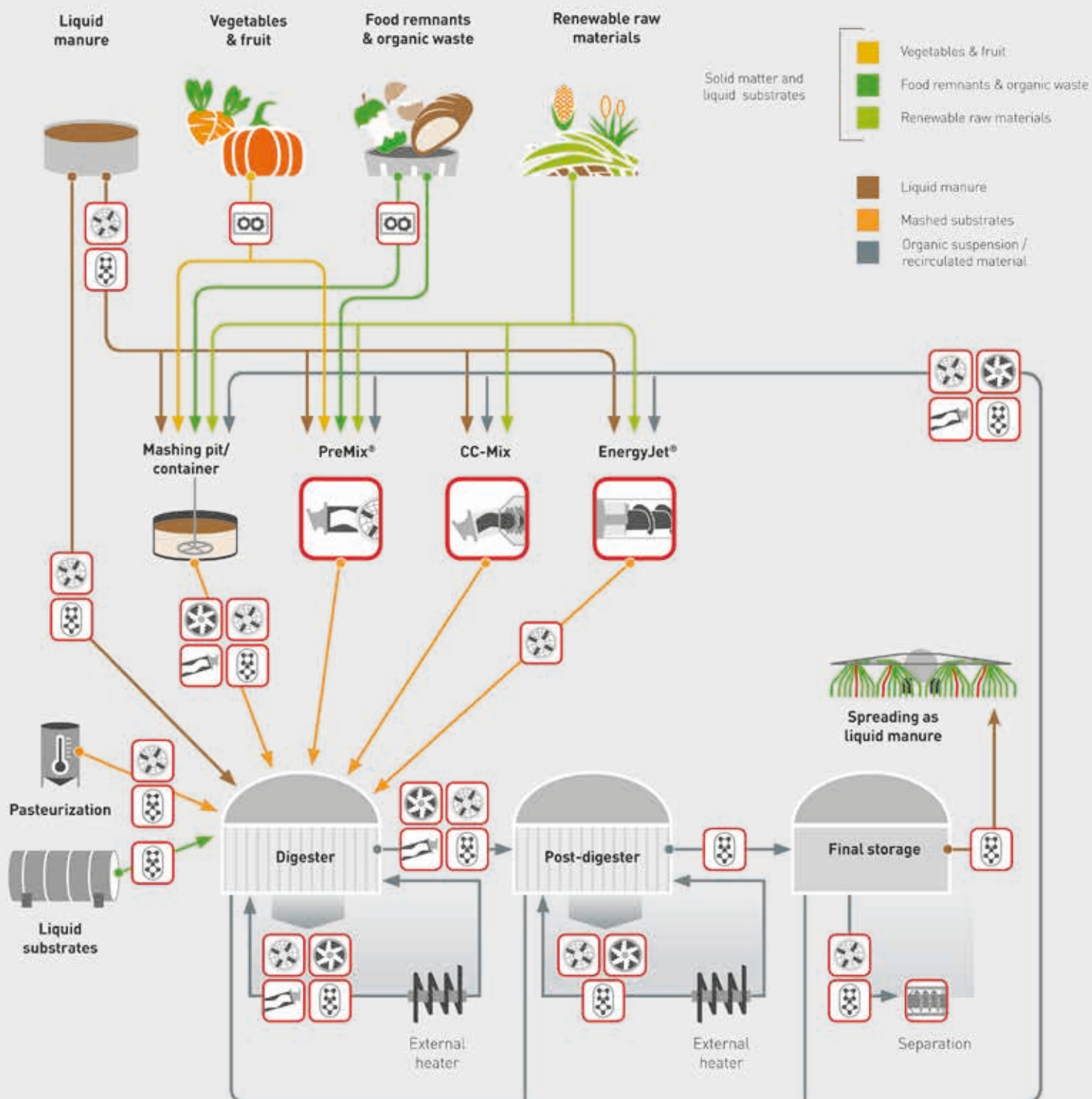

WHEN IT COMES TO SERVICE, WE LEAVE NOTHING TO CHANCE

**Comprehensive services
for smooth operation and
a long lifetime**

Support and supply from A to Z

Because we are aware that close customer proximity is essential for our mutual success, we design our services to best meet your needs. In Germany and in countries where we have subsidiaries, Vogelsang service centers and contractual partners generate an active dialog with our customers and provide reliable support.

This means you always get the precise support you need in every phase of our partnership. Our highly qualified staff make it possible – experts such as consultants and technicians who know your Vogelsang machines inside and out.



Since its establishment in 1929, Vogelsang has become an internationally recognized mechanical engineering company with numerous branches, sales centers and subsidiaries.



We think ahead

Thinking ahead in your best interest begins with our extensive and detailed product documentation. Spare parts are available within a short time due to our high degree of vertical integration in production. In addition, you will always find an authorized service partner in your area who can help with repairs and wear part replacement. The Vogelsang ServicePack completes the offer. Whether you need start-up, on-site training, training at the Vogelsang facility, or full service support with a maintenance contract and a wear parts service package – we offer a support program tailored specifically to your needs.

What we offer

We provide solutions in the following sectors:
AGRICULTURAL TECHNOLOGY, BIOGAS,
INDUSTRY, TRANSPORTATION, WASTEWATER



Our broad range of products and services

- Consulting and service
- Data management and control technology
- Disintegration technology
- Individually tailored solutions for special applications
- Pumps and pump systems
- Solid matter feeders
- Solids reduction, separators and mixers
- Spreading technology
- Supply, disposal and cleaning

Copyright 2024 Vogelsang GmbH & Co. KG

Product availability, appearance, technical specifications and details are subject to continuous development. All information presented here is therefore subject to change. In selected countries, Vogelsang®, BioCut®, BlackBird®, CC-Serie®, EnergyJet®, HiCone®, PreMix®, RotaCut®, XRipper®, XSplit® and XTill® are registered trademarks of Vogelsang GmbH & Co. KG, Essen (Oldenburg), Germany. All rights reserved, including the rights to all graphics and images.

Future-oriented biogas production_EN_04207724_MET0000133 – Printed in Germany

Vogelsang GmbH & Co. KG
Holthoeye 10 – 14 | 49632 Essen (Oldenburg) | Germany
Phone: +49 5434 83 - 0 | Fax: +49 5434 83 -10
germany@vogelsang.info

[vogelsang.info](https://www.vogelsang.info)



SPECIFICATION



FUTURE-ORIENTED BIOGAS PRODUCTION

Pumping, cutting and
feeding technology
machines and systems

VOGELSANG – LEADING IN TECHNOLOGY

HiCone[®]

The revolutionary progressive cavity pump with unrivaled low operating costs

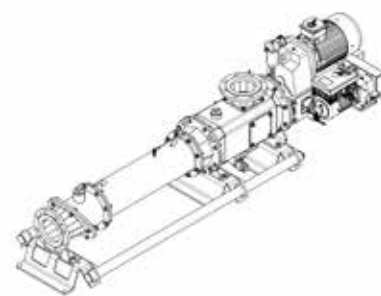

Type	Max. capacity*	Max. pressure	Max. free passage
	m ³ /h	bar	mm
HiCone 44	37	12	48
HiCone 55	75	12	62
HiCone 66	150	12	78
HiCone 77	290	12	98

* Maximum theoretical capacity. In practice, the capacity is normally lower, depending on pressure difference, medium viscosity and pump installation. We would be happy to configure the best progressive cavity pump for your application with the help of our computer-assisted sizing software.

CC series

The practical CavityComfort progressive cavity pump for heavy-duty applications

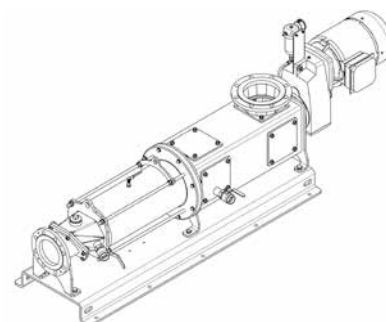

Type*	Max. capacity**	Max. pressure	Max. free passage
	m ³ /h	bar	mm
CC44 - M1	40	6	63
CC44 - M2	40	12	63
CC44 - D1	80	6	63
CC55 - M1	80	6	73
CC55 - M2	80	12	73
CC55 - D1	165	6	79
CC66 - M1	145	6	88
CC66 - M2	145	12	88
CC66 - D1	290	6	95
CC77 - M1	225	6	108
CC77 - M2	225	12	108

* D1/M1: single-stage progressive cavity pump, M2: two-stage progressive cavity pump.

** Maximum theoretical capacity. In practice, the capacity is normally lower, depending on pressure difference, medium viscosity and pump installation. We would be happy to configure the best progressive cavity pump for your application with the help of our computer-assisted sizing software.

VX series

Vogelsang VX series rotary lobe pumps –
proven reliable in the widest variety of pumping tasks

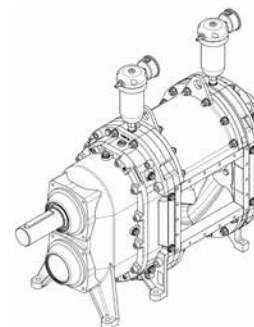

Type	Stroke volume	Max. capacity*	Max. pressure		Max. speed	Max. shaft deflection	
			Q bar	QD bar		Q mm/bar	QD mm/bar
	l/rev.	m ³ /h			min ⁻¹		
VX136 series							
70	1.27	61	10	12	800	0.01	0.002
105	1.90	91	10	12	800	0.03	0.004
140	2.53	121	8	12	800	0.05	0.007
210	3.80	182	5	10	800	0.16	0.016
280	5.06	243		8	800		0.031
420	7.59	364		6	800		0.090
VX186 series							
92	3.56	128	10		600	0.01	
130	5.03	181	10	12	600	0.02	0.003
184	7.21	256	8	12	600	0.05	0.008
260	10.06	362	5	10	600	0.12	0.012
368	14.24	513	2 [3**]	8	630	0.33	0.028
390	15.09	543	2 [3**]	7	600	0.40	0.028
520	20.12	724		6	600		0.065
736	28.48	1,025		3	600		0.191
VX215 series							
226	15.47	501	5	8	540	0.10	0.010
320	21.88	708	2,5	7	540	0.29	0.026
452	30.94	1,002		5	540		0.069
640	43.76	1,417		3	540		0.167
VX230 series							
226	13.45	436	8	12	540	0.05	0.006
320	19.04	617	5	10	540	0.13	0.012
452	26.90	872		10	540		0.029
640	38.08	1,234		6	540		0.073

* Maximum theoretical capacity. In practice, the capacity is normally lower, depending on pressure difference, medium viscosity and pump installation. We would be happy to configure the best rotary lobe pump for your application with the help of our computer-assisted sizing software.

** Not in continuous operation.

IQ series

Greater cost-effectiveness thanks to reduced maintenance and service

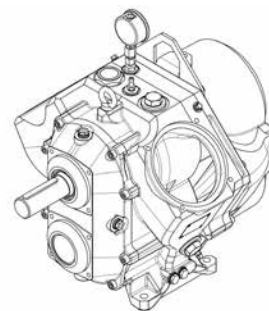

Type	Stroke volume	Max. capacity*	Max. pressure	Max. speed	Max. shaft deflection
	l/rev.	m ³ /h	bar	min ⁻¹	mm/bar
IQ152-112	2.61	110	7	700	0.03
IQ152-158	3.67	154	5	700	0.08

* Maximum theoretical capacity. In practice, the capacity is normally lower, depending on pressure difference, medium viscosity and pump installation. We would be happy to configure the best rotary lobe pump for your application with the help of our computer-assisted sizing software.

RotaCut[®]

The RotaCut[®] macerator with integrated heavy material separator for reliable processes and low maintenance costs

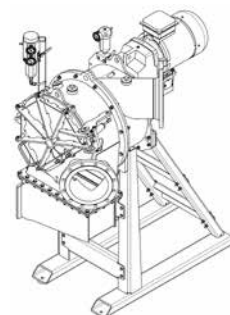

Type	Max. throughput*	Optional speed	Optional drive power	Hydraulic motor	Heavy material separator / available design	Cutting screen with available free passage
	m ³ /h	min ⁻¹	kW			mm
RC 3000	180	76 - 326	1.5 - 4.0	x	Inline, MXL	4 8 10 12 15 20 28
RCQ - 26	180	72 - 326	2.2 - 5.5		Inline	4 8 10 12 15 20 28
RC 5000pro	300	66 - 330	1.5 - 7.5	x	Inline, Compact XL, MXL	4 6 8 10 12 15 24 30
RCQ - 33pro	300	115 - 292	5.5 - 7.5		Inline, Compact XL	4 6 8 10 12 15 24 30
RC 1000pro	600	66 - 319	2.2 - 7.5	x	Inline, Compact XL, MXL	4 8 10 12 16 20 25 34 38
RCQ - 43pro	600	115 - 292	5.5 - 7.5		Inline, Compact XL	4 8 10 12 16 20 25 34 38
RCX - 48	600	114 - 311	5.5 - 11		RCX, DRS	4 8 10 12 16 20 25 34 38
RCX - 58	750	94 - 276	7.5 - 15	x	RCX, DRS, MXL	4 8 10 12 16 25 34 40 50
RCX - 68	1,200	98 - 243	11 - 18.5		RCX, DRS	30 40 50

* Throughput depending on DS content.

BioCut[®] and CC-Cut

The BioCut[®] and CC-Cut developed specially for biogas plants – positive displacement pump and macerator in one

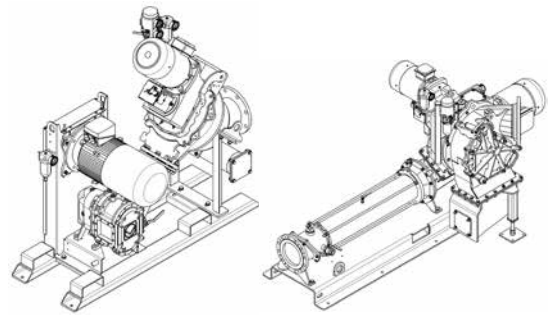

Model		Rated capacity	Max. pressure	Installed drive power	
Pump	RotaCut			Pump kW	RotaCut kW
BioCut					
VX136 - 105Q	RCQ - 26G	25	4	7.5	4
VX136 - 105Q	RCQ - 33Gpro	30	4	7.5	5.5
VX136 - 140Q	RCQ - 33Gpro	42	4	11	5.5
VX186 - 130Q	RCQ - 43Gpro	98	4	22	7.5
CC-Cut*					
CC44 - M2	RCQ - 33Gpro	10	8	5.5	5.5
CC44 - D1	RCQ - 43Gpro	27	4	7.5	7.5
CC55 - M2	RCQ - 33Gpro	20	8	9.2	5.5
CC55 - D1	RCX - 48G	50	4	11	8.3
CC66 - M2	RCX - 48G	30	8	15	8.3
CC66 - D1	RCX - 58G	90	4	18.5	16.5
CC77 - M2	RCX - 58G	70	8	22	16.5

* D1: single-stage progressive cavity pump, M2: two-stage progressive cavity pump.

RedUnit XRL

The RedUnit XRL twin-shaft shredder for processing voluminous solids

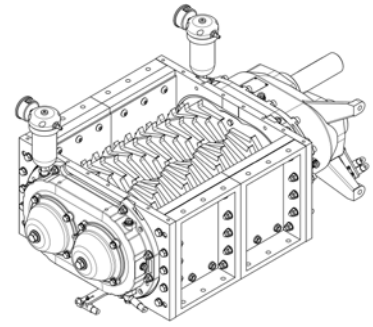

Type	Blade widths	Max. capacity*	Input opening	Installed drive power
	mm	m ³ /h	mm (L x W)	kW
XRL136 - 200QD	6 10 14	6	200 x 320	4 - 5.5
XRL136 - 280QD	6 10 14	10	280 x 320	4 - 11
XRL136 - 560QD	6 10 14	20	560 x 320	4 - 11
XRL186 - 260QD	8 11 16 32	20	260 x 445	11 - 15
XRL186 - 520QD	8 11 16 32	40	520 x 445	11 - 22
XRL186 - 780QD	8 11 16 32	60	780 x 445	11 - 22
XRL260 - 800	16 25 40	85	800 x 598	2 x 22 - 37
XRL260 - 1200	16 25 40	130	1,200 x 598	2 x 22 - 37
XRL260 - 1600	16 25 40	175	1,600 x 598	2 x 22 - 37

* Refers to easy-to-reduce solids.

DebrisCatcher

The DebrisCatcher: maximum plant protection thanks to active heavy matter separation

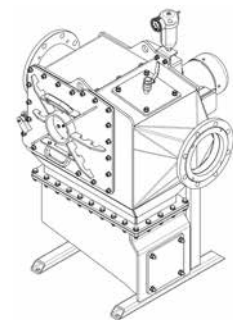

Max. throughput*	Max. pressure	Installed drive power	Optional free passage	Connections	Settling tank with available design
m ³ /h	bar	kW	mm	DN	
200	4	2.2	12 25 40	150 / 200	Standard DRS

* Throughput depending on DS content.

DisRuptor

The individually adaptable DisRuptor for mechanical disintegration of solids

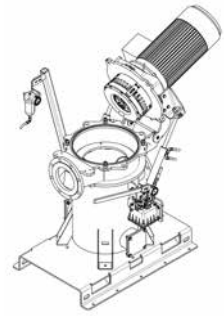

Type	Max. throughput*	Max. pressure	Installed drive power	Drive speed	Connections	Design available
	m ³ /h	bar	kW	min ⁻¹	DN	
DR7000	200	4	15 22	975	150 200	Inline Compact XL

* Throughput depending on DS content.

XSplit[®]

The innovative press screw separator with excellent cost-benefit ratio and unique benefits

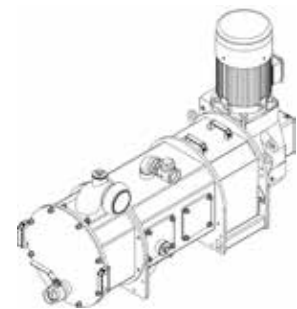

Type	Max. throughput*	Max. dry matter content (DM)*	Speed	Installed drive power	Dimensions LxBxH
	m ³ /h	%	min ⁻¹	kW	mm
XS25-50	50	40	15 - 36	4 - 7.5	1,450 x 550 x 950

* Maximum values.

What we offer

We provide solutions in the following sectors:
AGRICULTURAL TECHNOLOGY, BIOGAS,
INDUSTRY, TRANSPORTATION, WASTEWATER



Our broad range of products and services

- Consulting and service
- Data management and control technology
- Disintegration technology
- Individually tailored solutions for special applications
- Pumps and pump systems
- Solid matter feeders
- Solids reduction, separators and mixers
- Spreading technology
- Supply, disposal and cleaning

Copyright 2024 Vogelsang GmbH & Co. KG

Product availability, appearance, technical specifications and details are subject to continuous development. All information presented here is therefore subject to change. In selected countries, Vogelsang®, BioCut®, BlackBird®, CC-Serie®, EnergyJet®, HiCone®, PreMix®, RotaCut®, XRipper®, XSplit® and XTill® are registered trademarks of Vogelsang GmbH & Co. KG, Essen (Oldenburg), Germany. All rights reserved, including the rights to all graphics and images.

Future-oriented biogas production_EN_TD_04207724_MET0000134 – Printed in Germany

Vogelsang GmbH & Co. KG
Holthöge 10 – 14 | 49632 Essen (Oldenburg) | Germany
Phone: +49 5434 83 - 0 | Fax: +49 5434 83 -10
germany@vogelsang.info

vogelsang.info

